

moda

Be My Neighbor

Block 9
15" x 18" finished

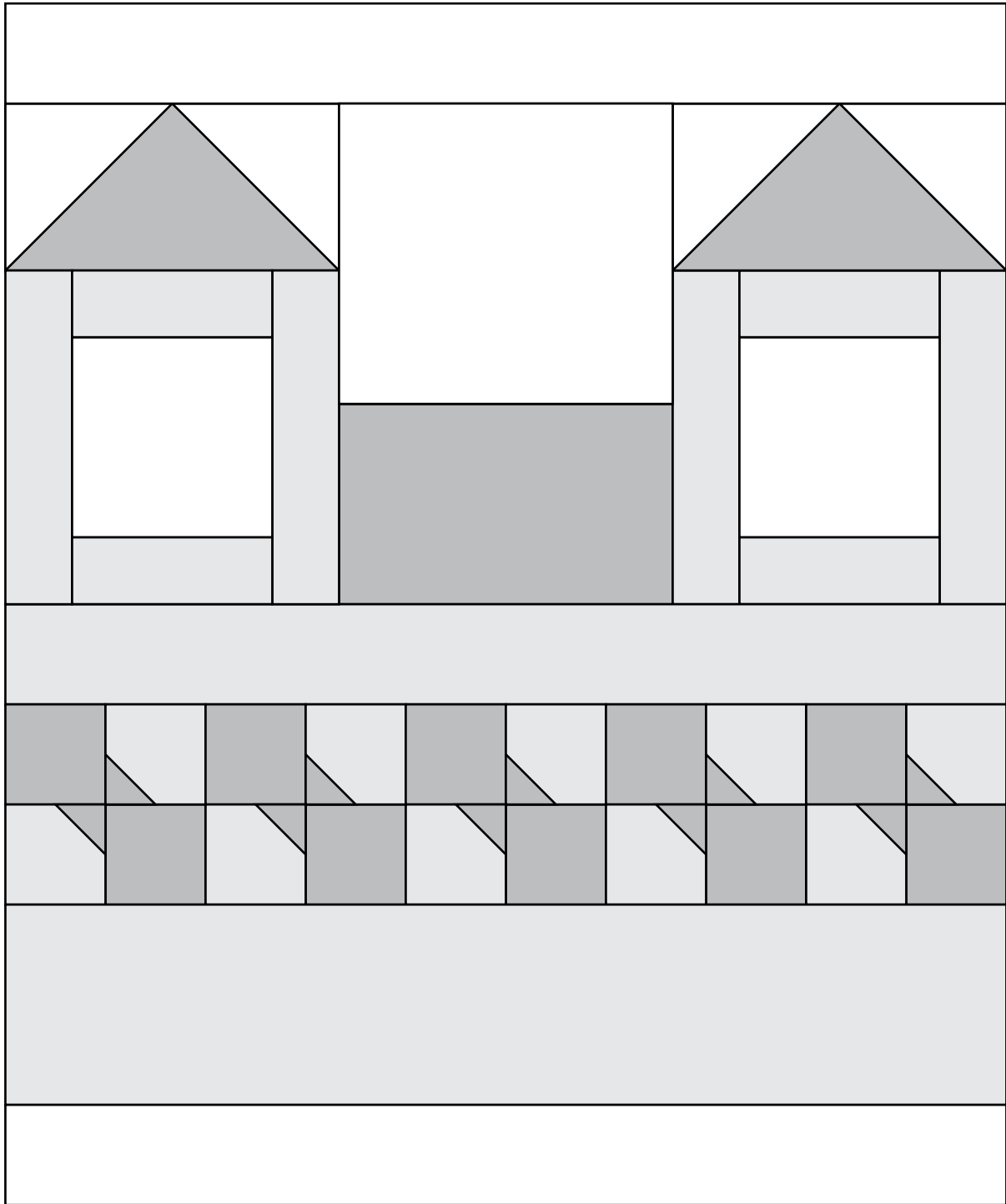

General Information

- These are very scrappy blocks. Mix your favorite Moda prints to create your colorful neighborhood!
- Share your progress and final quilt at #BeMyNeighbor. We love to see your results!!!

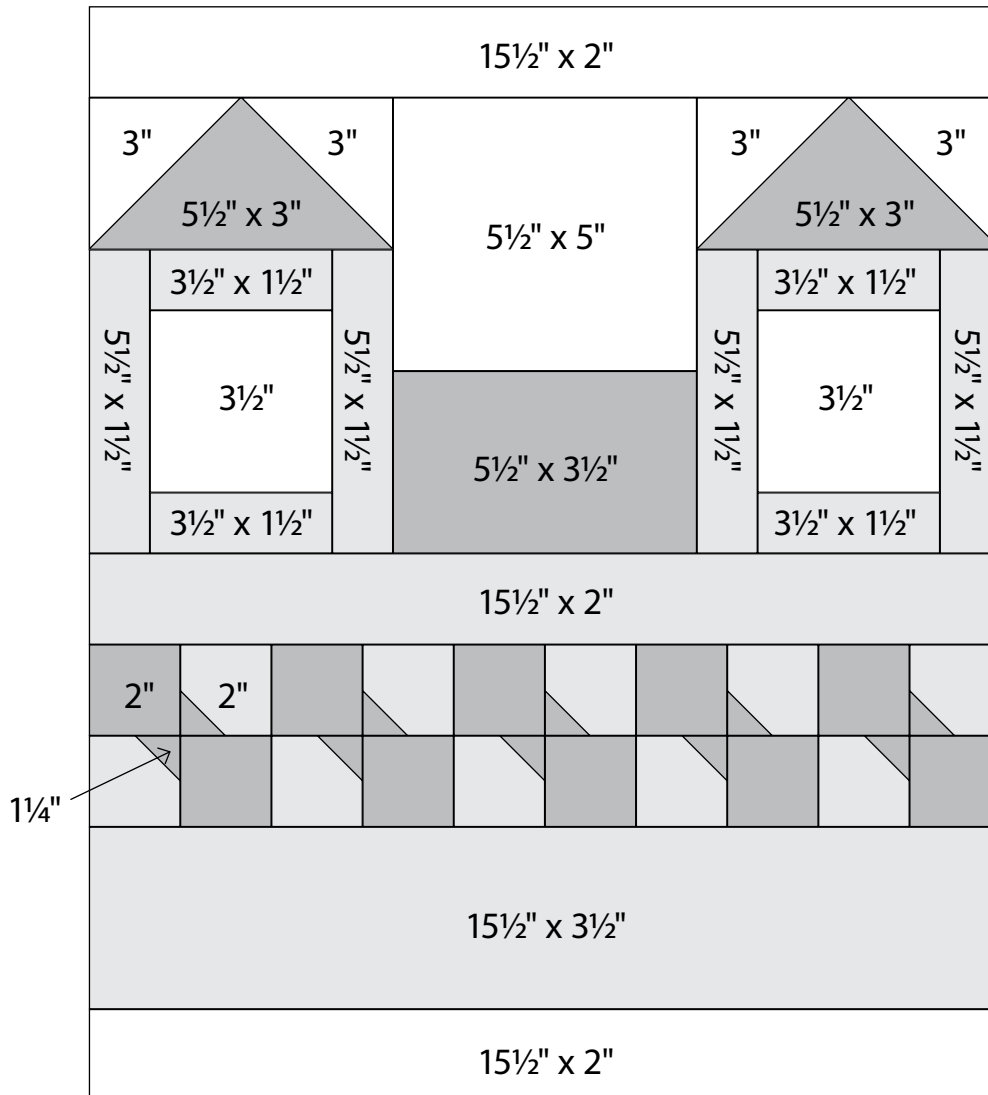

Block 9
15 1/2" x 18 1/2" unfinished

Cutting

House Roof

- 1-5 1/2" x 3 1/2" rectangle
- 2-5 1/2" x 3" rectangles

Bowties (5 total)

- For EACH bowtie cut
- 2-2" squares and 2-1 1/4" squares

Windows

- 2-3 1/2" squares

House

- 1-15 1/2" x 3 1/2" rectangle
- 1-15 1/2" x 2" rectangle
- 10-2" squares
- 4-5 1/2" x 1 1/2" rectangles
- 4-3 1/2" x 1 1/2" rectangles

Background

- 2-15 1/2" x 2" rectangles
- 1-5 1/2" x 5" rectangles
- 4-3" squares

Be My Neighbor

Block 9 is 15" x 18" finished.

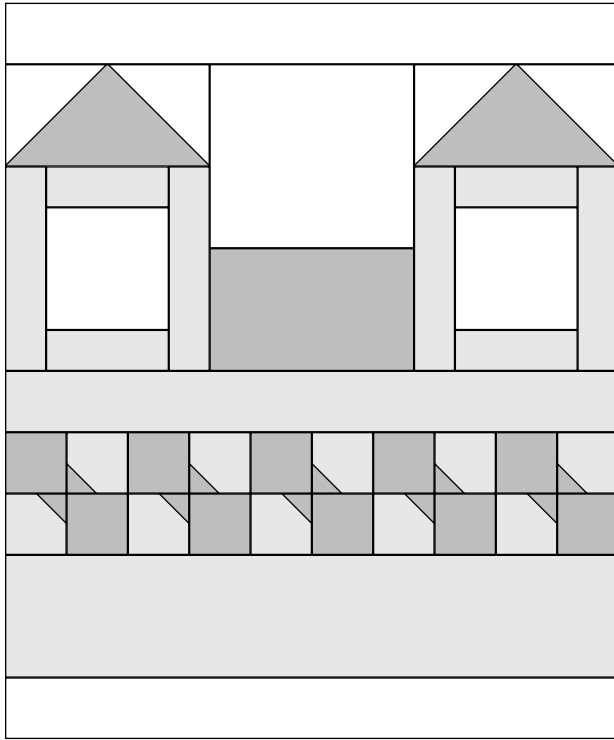

House Rooftops and Windows continued . . .

(B) Assemble windows and rooftops as shown.

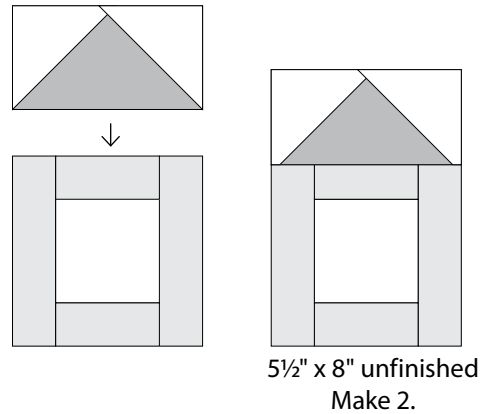
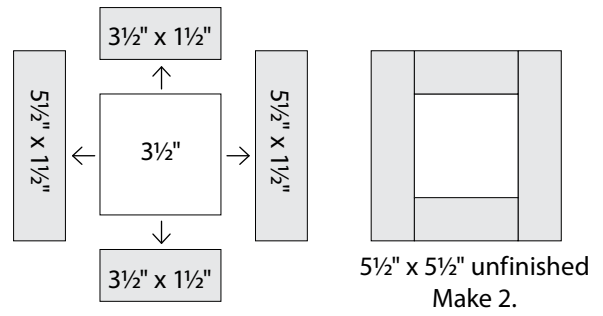

Construction

Use 1/4" seams. Press in the direction of the arrows in the diagrams.

1 House Rooftops and Windows

- (A) Draw a diagonal line from corner to corner on the wrong side of 4-3" background squares. Layer a 3" marked background square, right sides together, on 1-5 1/2" x 3" roof rectangle as shown. Sew on the diagonal line. Trim 1/4" from the sewn line. Press to reveal the triangle. Repeat on the opposite end of the same rectangle. Make 2.

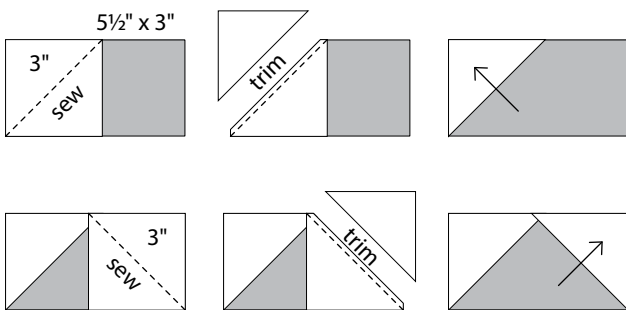

House
5 1/2" x 3" unfinished
Make 2.

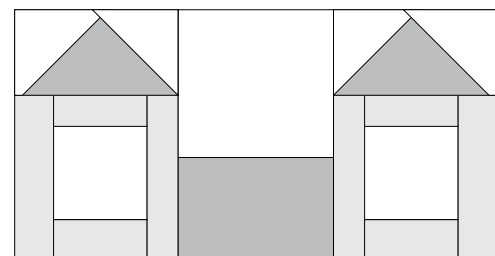
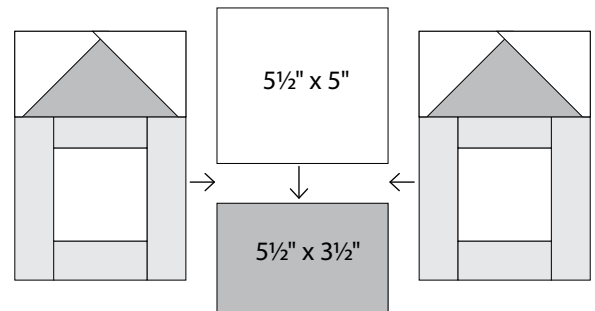

15 1/2" x 8" unfinished

2 To make one Bowtie

(A) Draw a diagonal line from corner to corner on the wrong side of 2-1¼" bowtie squares. Layer a 1¼" marked bowtie square, right sides together, on 1-2" house square as shown. Sew on the diagonal line. Trim ¼" from the sewn line. Press to reveal the triangle. Make 2.

Arrange and sew 2 rows of 1-2" bowtie square and 1 bowtie as shown. Join the rows. Repeat to make 5 bowties.

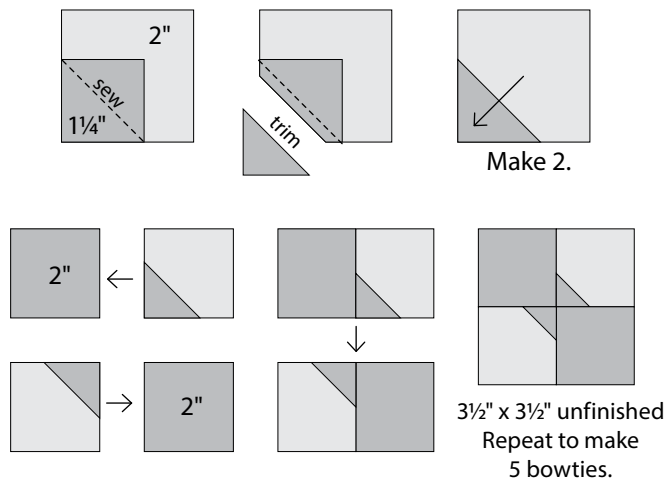

(B) Join the 5 bowties in one row.

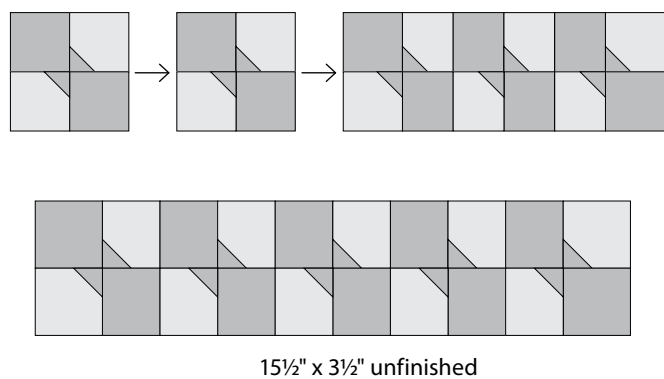

moda

3 Assemble the block as shown.

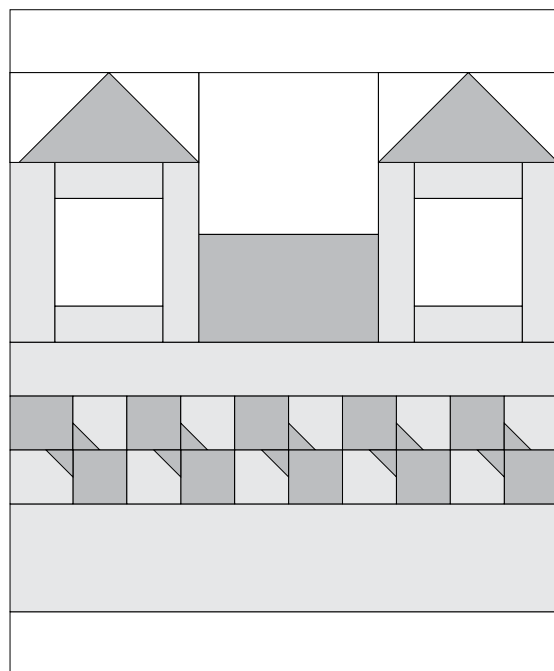
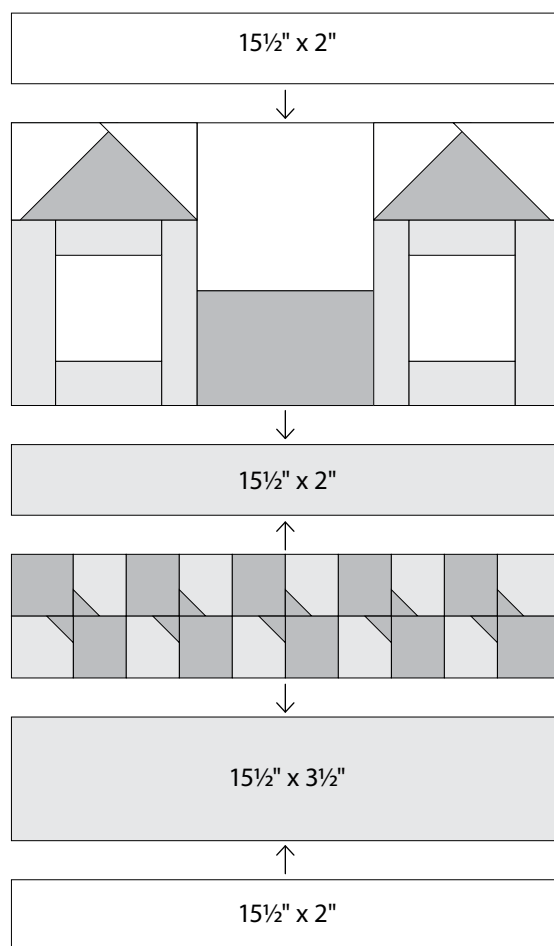

Block 9
 15 1/2" x 18 1/2" unfinished